

# MORE FROM WOOD.

Quality management ISO 9001



Coding: PI WT UK EN  
Revision: 00  
Approved: 19.12.2019  
Page: 1 of 15

## Processing instructions

EGGER Worktops



Due to their functionality EGGER worktops are used in kitchens, bathrooms and offices, but also for shopfitting solutions and domestic furniture. Whatever they encounter on a daily basis, the surfaces will retain their high performance characteristics providing that you follow our recommendations on processing and assembly very closely. The following instructions are for a kitchen work surface.

### Content

1. Description of the material .....	1
2. Transport, storage and handling .....	3
3. Processing .....	4
4. Fabrication and assembly .....	7
5. Maintenance and cleaning recommendations .....	15
6. Handling of scraps .....	15
7. Additional documents / Product information .....	15

### 1. Description of the material

The worktop range from EGGER is diverse and includes other models and options in addition to the classic postforming worktop.

Postformed Worktop – Model 300/3



- 1 Laminate
- 2 Eurospan chipboard, 38 mm
- 3 High density protective layer
- 4 Balancer
- 5 UV lacquer seal
- 6 Seal



## MORE FROM WOOD.

Quality management ISO 9001

**E EGGER**

Coding: PI WT UK EN  
Revision: 00  
Approved: 19.12.2019  
Page: 2 of 15

### Feelwood Square Edged Worktop – Model 100/1.5



- 1 Laminate XL – Feelwood
- 2 Eurospan chipboard, 38 mm
- 3 ABS-edging, 1.5 mm
- 4 Laminate balancer

### PerfectSense Topmatt Thin Square Edged Worktop – Model 100/1.5



- 1 Laminate PerfectSense Topmatt
- 2 MDF, 16 mm
- 3 ABS-edging, 1.5 mm
- 4 Laminate balancer

### Square Edged Worktop – Model 100/1.5

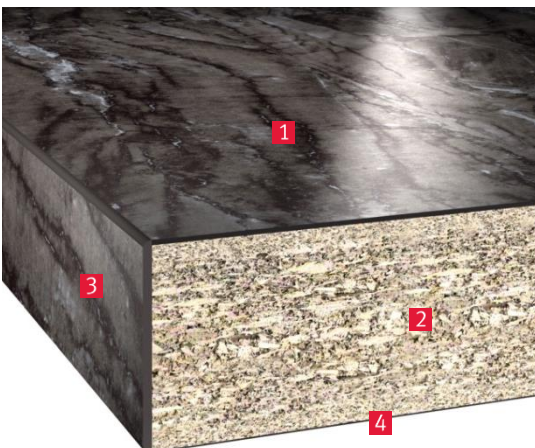

- 1 Laminate
- 2 Eurospan chipboard, 25 mm
- 3 ABS-edging, 1.5 mm
- 4 Laminate balancer

## MORE FROM WOOD.

Quality management ISO 9001

**E EGGER**

Coding: PI WT UK EN  
Revision: 00  
Approved: 19.12.2019  
Page: 3 of 15

### Thin Square Edged Worktop – Model 100/1.5

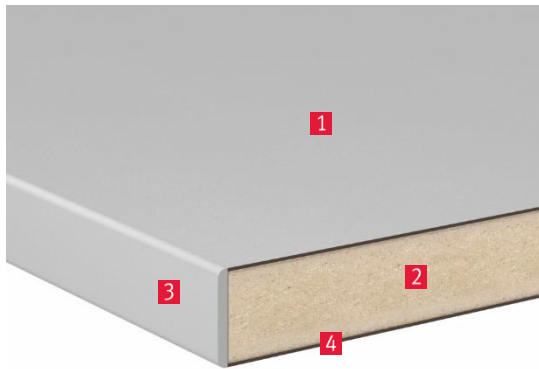

- 1 Laminate
- 2 MDF, 16 mm
- 3 ABS-edging, 1.5 mm
- 4 Laminate

## 2. Transport, storage and handling

### 2.1 Transport

The worktops are usually packaged and transported as shown – see figure 1. The packages must be transported dry and must not be exposed to the weather. In addition, the load must be secured against slipping and falling over in the case of transport by using suitable securing means (lashing straps, tensioning straps, etc.). Anti-slip mats should be used to prevent the load from slipping. When manually transporting long worktops, especially “Thin Square Edged Worktop” and “PerfectSense Topmatt Thin Square Edged Worktop”, these must be carried on edge to prevent bending.

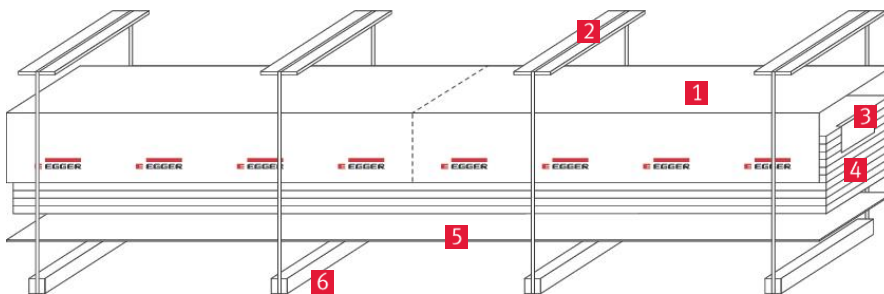

- 1 Carton
- 2 Plastic tape
- 3 Pallet label
- 4 Worktops
- 5 Cover board
- 6 Underlays

Figure 1

The worktops must be unpacked after delivery and stored in accordance with chapter 2.2. This is the only way to ensure optimum conditions for further processing of the worktops.

### 2.2 Storage and conditioning

Worktops must be stored in closed and dry rooms, protected from moisture. In addition, normal climatic conditions should be present in the rooms.

Once the original packaging is removed, the worktop must be stored on full-surface, horizontal, straight, stable protective boards. Direct floor contact and/or exposure to sunlight must be avoided at all times. A laminated protective board (no raw chipboard) of at least the same format must be used to cover the top.

Prior to assembly, worktops should be conditioned for an adequate period of time at the installation location under the conditions of subsequent use. Compliance with the storage recommendations is required on construction sites as well.

### 2.3 Handling

After removing the packaging and prior to processing, the worktops should be inspected for visible damage. In view of the relatively heavy weight, special care is required when transporting and handling worktops. As a rule, all persons transporting and / or handling worktops should wear personal safety equipment such as gloves, safety footwear and suitable work wear. The boards must be lifted. The decor sides should never be pushed against one another or dragged over one another.

## 3. Processing

As described in chapter 2.2, ensure that the worktops are adequately conditioned before processing. The worktops must be conditioned for at least 24 hours under normal climatic conditions before processing.

### 3.1 Extraction

Compliance with all safety standards and regulations, applicable to the wood processing industry in terms of dust extraction, fire prevention etc., is essential when processing worktops. Breathing protection has to be worn if no adequate extraction system is in place. Fabricating worktops is not a critical issue, but there are people who can experience an allergic reaction to all types of dust.

### 3.2 Cutting

The worktops can be cut to size using standard woodworking equipment, e.g. panel saws, bench circular saws, hand-held circular saws or jigsaws and also CNC routers. Panel saws or bench circular saws are generally used to cut the worktops to size. A good cutting result depends on different factors including whether the decor side is facing upwards, saw blade projection, feed rate, tooth shape, tooth spacing, motor speed and cutting speed.

**Example – Circular saw:**

Cutting speed: approx. 40 to 60 m/sec.  
 Rotational speed: approx. 3,000 to 4,000 rpm.  
 Feed rate: approx. 10 to 20 m/min (manual feed)

With the exception of panel saws and CNC routers, all cutting involves manual feed. Due to the high-quality melamine resins used for the surface of the EGGER laminate, the tool wear is considerably greater than with conventional wood-based materials. We recommend that you use carbide metal-tipped or even diamond-tipped saws cutters or router bits.

Use the following tooth shapes depending on the standard of finish you require (coarse or fine cut) – see figure 2.

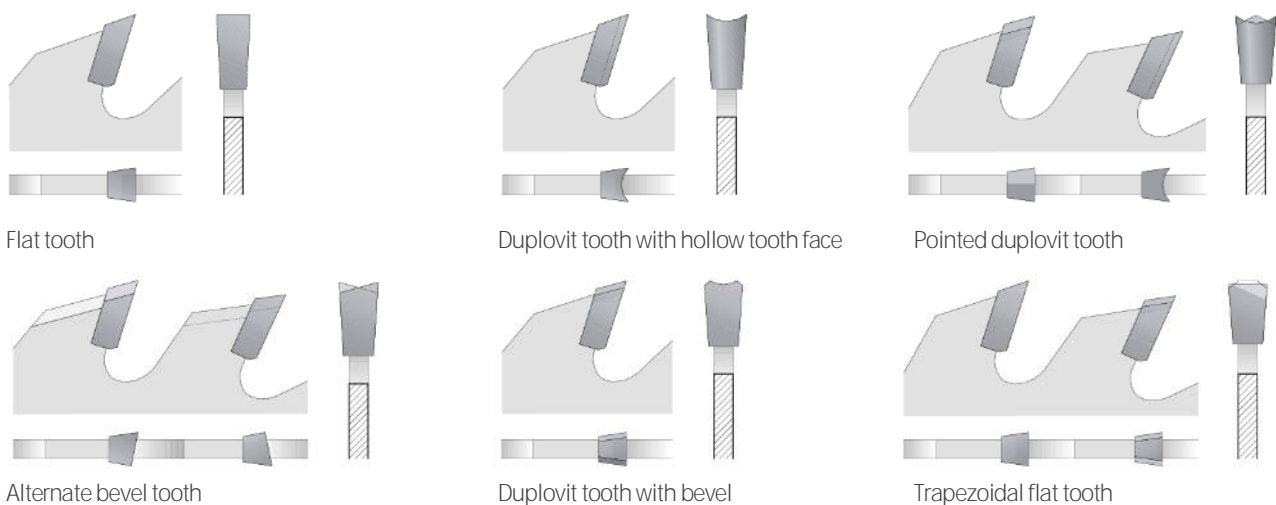

Figure 2



## MORE FROM WOOD.

Quality management ISO 9001

**E EGGER**

Coding: PI WT UK EN  
 Revision: 00  
 Approved: 19.12.2019  
 Page: 5 of 15

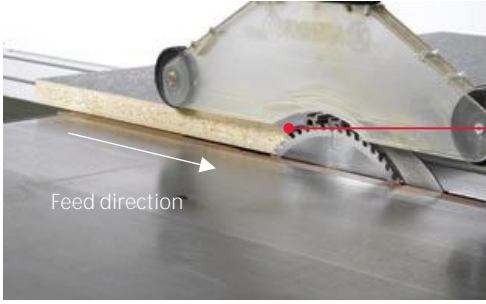
Use a cutting guide when working with a hand-held circular saw or jigsaw. Cutting must be from the underside of the board.

Saw type	Decor side	Application
<p><b>Panel or bench circular saws</b></p> <p>The worktop lies on the guide carriage and is guided towards the bench circular saw.</p> <p>Front edge towards the guide rail.</p>	above	 <p>Front edge of the worktop</p> <p>Feed direction</p>
<p><b>Hand-held circular saws or jigsaws</b></p> <p>The hand-held circular saw is guided against the worktop.</p> <p>Front edge towards the operator.</p>	underside	 <p>Feed direction</p> <p>Front edge of the worktop</p>

### 3.3 Edges and edging

The exposed edges of the EGGER worktop can be edged with thermoplastic EGGER ABS edge banding or EGGER melamine edging tape. For the manual application of melamine edging, normally PVAc glues or contact adhesives are used. The PVAc glue is evenly applied to the clean and dust-free chipboard edge using a paint brush. Then the melamine edging is pressed on with an edge press, glue press clamp or screw clamp using a stiff block of wood for protection and ensuring that there is sufficient overhang of edging on both the face and the underside of the worktop. The setting time can be substantially decreased by using heating bars.

Please follow the instructions provided by the machine manufacturer and adhesive supplier.

Edge milling cutters, files, chisels or sharp block planes are used for the finishing of melamine edging. The cutting should always be with light pressure at an oblique angle against the edge (shear action). EGGER melamine and ABS edges are used for the protection and design of worktops. Exposure to moisture in unprotected areas of the edges and well as in the hob and sink cut outs will lead to swelling. This is also the case with worktops which have a P3 (V100) chipboard core, which is often misleadingly described as 'moisture resistant'.

For more detailed information please refer to the "EGGER Edging ABS" processing information.

### 3.4 Cut-outs

Before processing, ensure that the worktop is supported securely so that the sawing, routing or drilling work is not likely to cause any damage. In particular, narrow board areas surrounding apertures can break or crack if the board is inappropriately handled during processing. The board cut-outs should also be secured so that they cannot break or fall out in an uncontrolled way and thereby cause injury to individuals or damage property.

Oven and sink cut-out edges should be radiused (minimum radius > 5 mm) as sharp edges have an adverse effect on the material and can lead to crack formation – see figures 3 and 4. This applies particularly to the hob area where the frequent exposure to heat causes the laminate to dry out, thereby increasing shrinkage tension.

Please specifically observe the instructions and installation templates supplied by the respective manufacturer!

## MORE FROM WOOD.

Quality management ISO 9001

**E EGGER**

Coding: PI WT UK EN  
Revision: 00  
Approved: 19.12.2019  
Page: 6 of 15

The cut-outs should preferably be made using a portable hand router or CNC milling machine. When using jigsaws, the cut-out corners should be pre-drilled with an appropriate radius and the cut-out sawn out from radius to radius. You should cut from the underside of the board to prevent the laminate coating from ripping off. The edges should be finished by means of sandpaper, filing or manual top milling to eliminate cracks due to chipping.

Due to the high cutting pressure, a safe workpiece and tool control is particularly important. All edges should be smooth, free of cracks and notches – see figures 3 and 4. Grooves and folds must also be chamfered to prevent notches. For installed components, sufficient space must be provided for expansion.

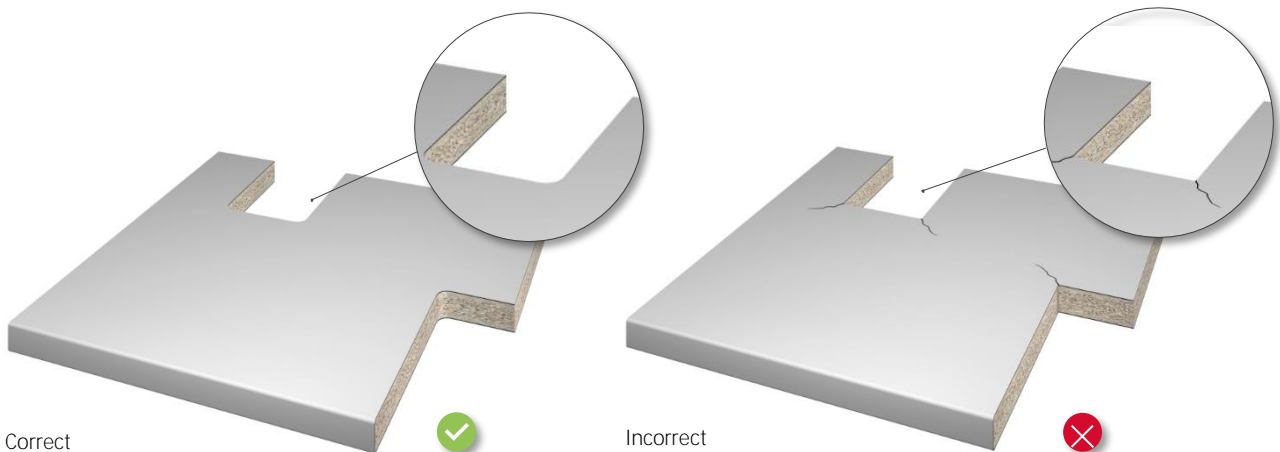

Figure 3

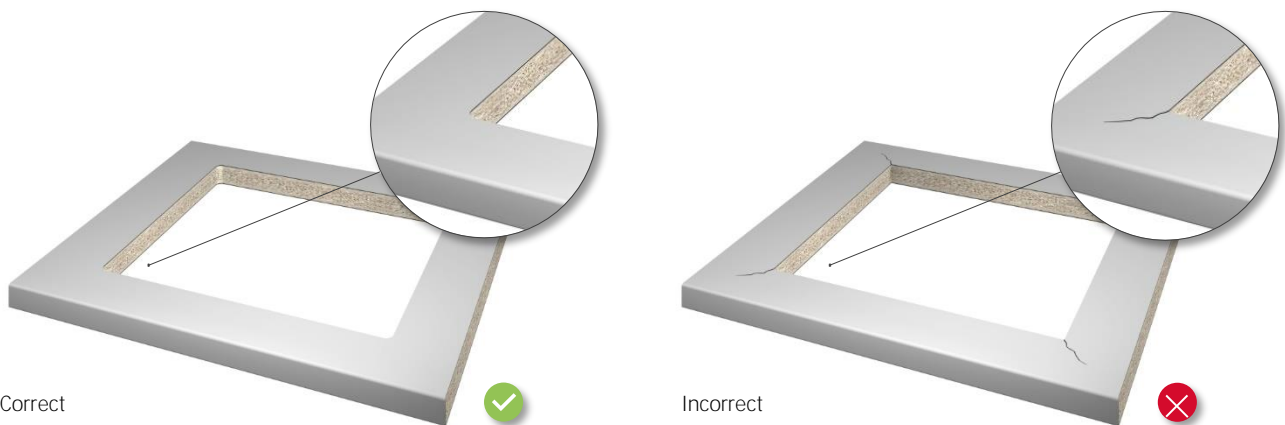

Figure 4

### 3.5 Sealing edges, cut-outs and drilled holes

EGGER worktops are effectively protected from moisture penetration by the laminate surface. Moisture and damp can still reach the substrate, however, via unprotected edges such as cut-outs, corner joints, mitres, long back edges, drill holes, screw holes and fixtures. This means that the necessary sealing work must be carried out in the final installation. The best products for sealing worktops have been found to be sealing profiles and self-curing sealants such as silicon rubber, polyurethane and acrylic.

When using sealing, you must also use a primer; either one that forms a film or a cleaning primer depending on the material.

You must follow the manufacturer's instructions carefully when using these materials.

## MORE FROM WOOD.

Quality management ISO 9001

**E EGGER**

Coding: PI WT UK EN  
Revision: 00  
Approved: 19.12.2019  
Page: 7 of 15

It is absolutely essential that you clean the areas you are sealing and to allow the manufacturer's specified venting time when using primer. Apply the sealant leaving no gaps or holes and then smooth over with water and detergent. Mask off areas near joints to prevent the surface from becoming dirty. Any pipes or leads that are to be brought up through the worktop should be centred with a minimum distance of 2 to 3 mm on either side and carefully sealed – see figure 5.

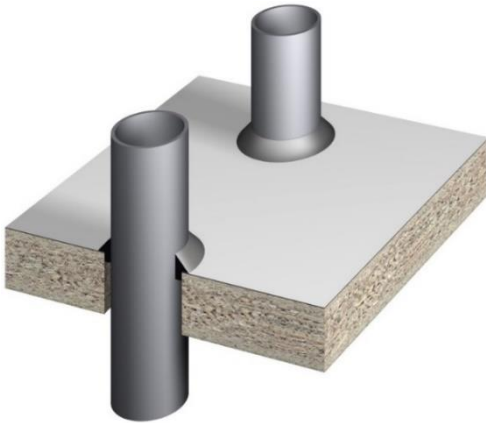

Figure 5

Cut edges can also be sealed using a two-part lacquer or two-part adhesive. Manufacturers supply sealing rings, profiles or collars with attachments such as mixer taps, sinks and hobs. Always follow the manufacturer's instructions when fitting these items.

The specially developed EGGER sealing is available for sealing joints that are created for worktop corner connections. The flexible seal prevents moisture and liquids from penetrating into the joint. Detailed information on EGGER Sealing can be found in chapter 4.2.

## 4. Fabrication and assembly

Worktops have good dimensional stability. Climate changes cause the worktop to shrink or expand, which means that format changes must be taken into account.

### 4.1 Installation of sinks and hobs

Cut-outs for hobs or sinks must be produced according to the measurements and positioning details and/or using templates supplied by the manufacturer. The cut-out edges must be carefully protected against moisture according to topic „Sealing edges, cut-outs and drilled holes“. Accompanying or integrated dry seals and fastening screws provided by the manufacturer must be used according to their assembly instructions – see figure 6.

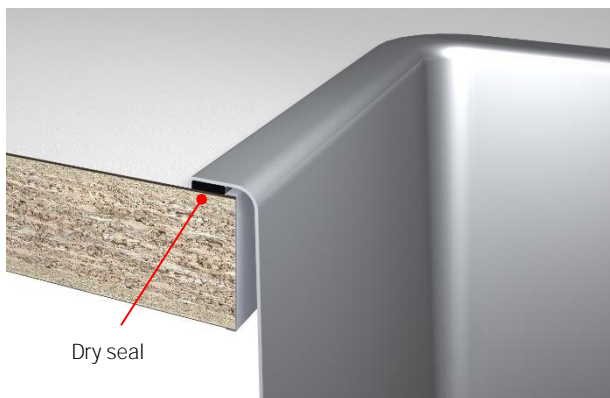

Figure 6



Figure 7

## MORE FROM WOOD.

Quality management ISO 9001



Coding: PI WT UK EN  
Revision: 00  
Approved: 19.12.2019  
Page: 8 of 15

For any type of hob - stainless steel, glass ceramics - the cut-outs should in all cases be made according to the instructions and installation templates supplied by the manufacturer. Ensure correct centring and an adequate safety margin to the cut edge, particularly for hobs. As additional protection against heat absorption we recommend also fitting self-adhesive aluminium tape or a metal profile around the edges – see figure 7. The hob must not abut against the surface for safety reasons, as a temperature increase of up to 150 K is possible in the event of faulty operation. Further assembly options are the surface-flush mounting – see figures 8 and 9. For this purpose, the core board is milled up to the laminate and then a resin frame is cast below the laminate.

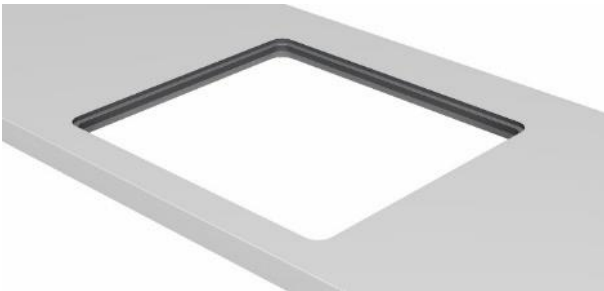

Figure 8

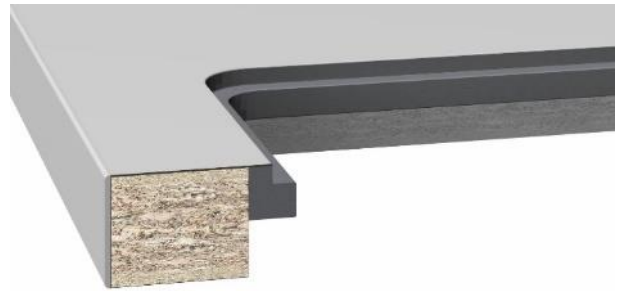

Figure 9

As commercial sinks are generally mounted on worktops approx. 38 mm thick, a special solution is required for the thin worktop options “Thin Square Edged Worktop” and “PerfectSense Topmatt Thin Square Edged Worktop”. The EGGER fastening set is offered for this purpose, which ensures simple installation – see figures 10 and 11.

For more detailed information, please refer to the technical leaflet "EGGER fastening set for sinks".

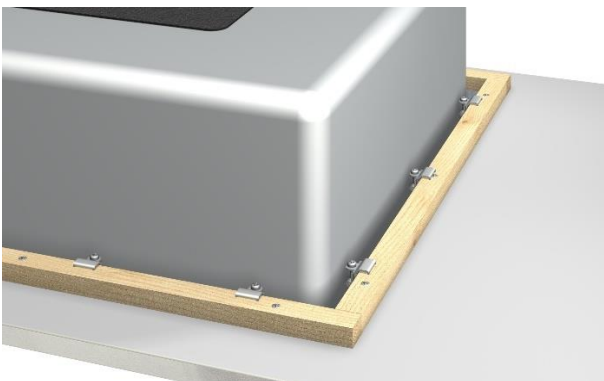

Figure 10



Figure 11

The worktop should not measure less than 50 mm at any one place. For ergonomic reasons, the distance between the hob area and an upright cupboard should not be less than 300 mm. Allow for the hob manufacturer's specified safety margin. The same distance is recommended for the gap between the sink and the hob – see figure 12.

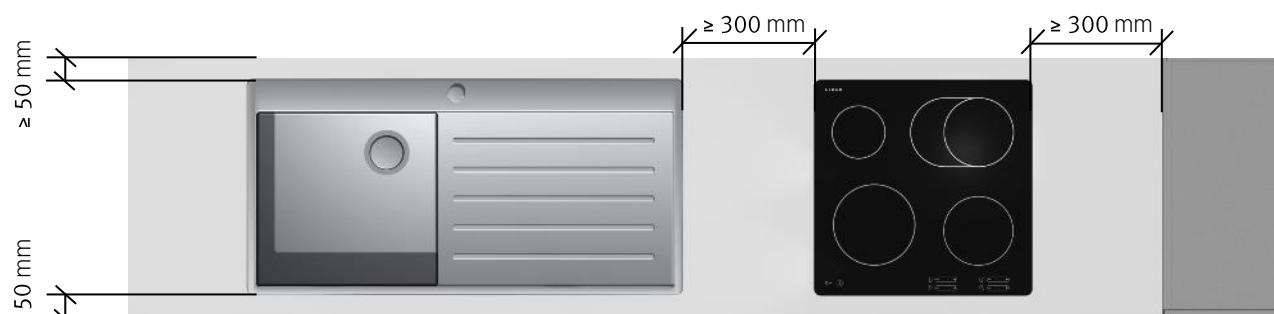

Figure 12



For safety reasons as much as for ergonomic reasons, kitchen designs should be discussed with a kitchen specialist and fitting carried out by a specialist company. Particularly electricity, gas and water supply connections must be carried out by trained specialists. In the region of corner connections, a minimum distance of 300 mm must be taken into account during planning – see figures 12-14.



Figure 13



Figure 14

Once the cut-out sections have been implemented in the worktops, any further transportation must be carried out while observing the utmost caution as to prevent “snapping at thin points”. Worktops should be carried upright because cut-outs and worktop can be damaged more easily if the boards are carried horizontally.

A standard construction can generally be used for conventional base units. In the construction of sink and/or cooker base units, the assembly of metal traverses has proven to be successful. The worktop is secured against possible bending by the metal traverse, as the worktops are weakened due to sink and/or hob cut-outs and the contact surface on the base units is minimized. Especially for the thin worktop versions “Thin Square Edged Worktop” and “PerfectSense Topmatt Thin Square Edged Worktop”, the use of EGGER metal traverses is recommended – see figure 15. In addition to stabilisation, the metal traverses are also used to secure the worktop or covers – see figure 16.

## MORE FROM WOOD.

Quality management ISO 9001



Coding: PI WT UK EN  
Revision: 00  
Approved: 19.12.2019  
Page: 10 of 15



Figure 15



Figure 16

For the assembly of the metal traverses, holes must be drilled in the cabinet sides. The drilling pattern contains two drill holes with  $\varnothing 8$  mm and 7 mm depth. A further hole with  $\varnothing 5$  mm and 13 mm depth must be drilled, provided that the fastening is carried out using a 6.3 x 13 mm Euro screw – see figures 17 and 18.

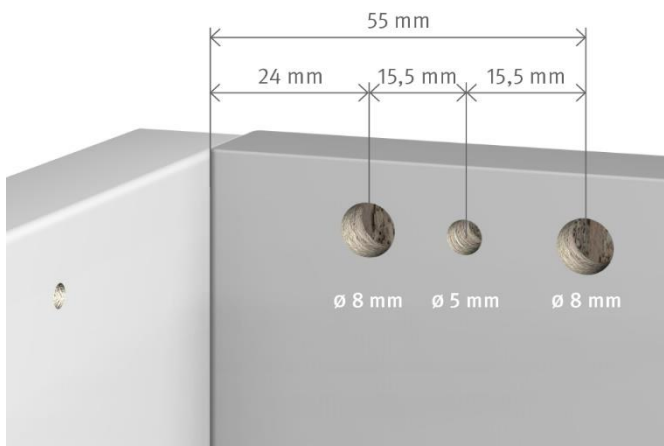

Figure 17



Figure 18

EGGER metal traverses are available for cabinet widths of 600, 800, 900, 1,000 and 1,200 mm, as well as for different cabinet side thicknesses.

For more detailed information, please refer to the technical leaflet "EGGER metal traverse for base cabinets".

### 4.2 Worktop joints and corner joints

In general, a worktop length of 4,100 mm means panel joints are avoided, whereas worktop corner joints are common. These should not be weakened by internal apertures or cut-outs such as for hobs or sinks – see figures 13 and 14. Corner joints on worktops are made by mitring on circular saws or routing using CNC routers and / or using special hand-held routers with the aid of templates – see figures 19 and 20.

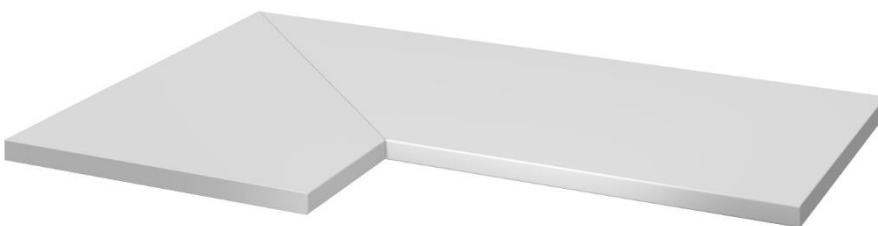

Figure 19

## MORE FROM WOOD.

Quality management ISO 9001

Coding: PI WT UK EN  
Revision: 00  
Approved: 19.12.2019  
Page: 11 of 15

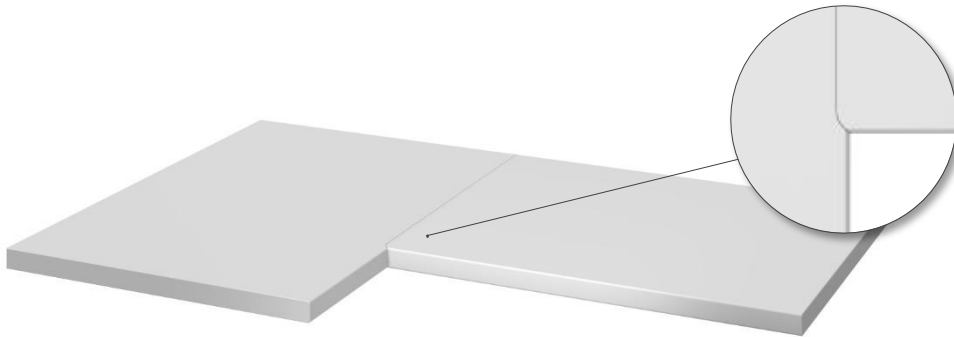

Figure 20

Alternatively, metal connection profiles can be fitted. These profiles are easy to install but can have a negative impact on the overall appearance of the work surface, as it breaks up the decor and can also be difficult to keep clean – see figure 21.

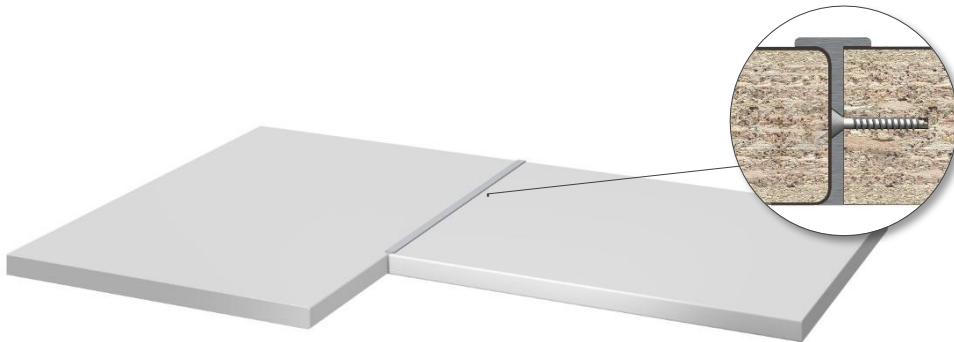

Figure 21

Worktop joints and corner connections need to fit perfectly and be completely sealed, and not just for aesthetic reasons. They need to repel any moisture which can cause swelling of the chipboard. For this purpose, EGGER Sealing was specially developed for sealing the joints (corner joints) of kitchen worktops. The flexible sealing prevents moisture and liquids from penetrating into the joint. It is resistant to detergents, water, fats, oils etc. and is available in four different colours. The content of the 10 g tube is enough for an average joint length of 600 mm – see figure 22.

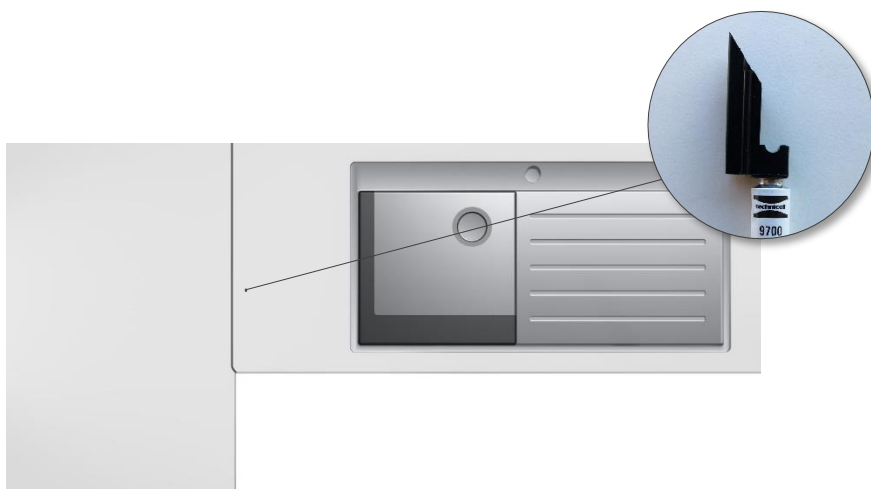

Figure 22

## MORE FROM WOOD.

Quality management ISO 9001

Coding: PI WT UK EN  
 Revision: 00  
 Approved: 19.12.2019  
 Page: 12 of 15

The application of the sealing begins with the perforation of the membrane closure of the tube and the following unscrewing of the black application support – see figure 22. In the following, the application support is guided along the upper side of the worktop joint and the sealing compound is evenly pressed out of the tube. Immediately after applying the sealing, the worktops must be joined and screwed together. Any leaked residue should be removed directly with a suitable cleaning product – see figure 23.

For more detailed information and recommended combinations of the colours for the respective worktop decors, please refer to the technical leaflet "EGGER sealing for corner connections".

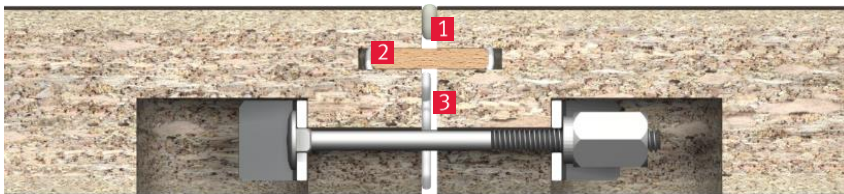

- 1 EGGER Sealing
- 2 Biscuits (Lamello)
- 3 Glue

Figure 23

The individual worktops are attached using worktop connectors as well as fixing supports, so-called biscuits, and additional glue to strengthen the bond – see figures 23 and 24. Depending on the worktop selection, different worktop connectors are required. The "Thin Square Edged Worktop" and "PerfectSense Topmatt Thin Square Edged Worktop" require the use of special worktop connectors due to their low material thickness. EGGER offers corresponding connectors as a set, suitable for 16 mm thick worktops. – see figure 25.

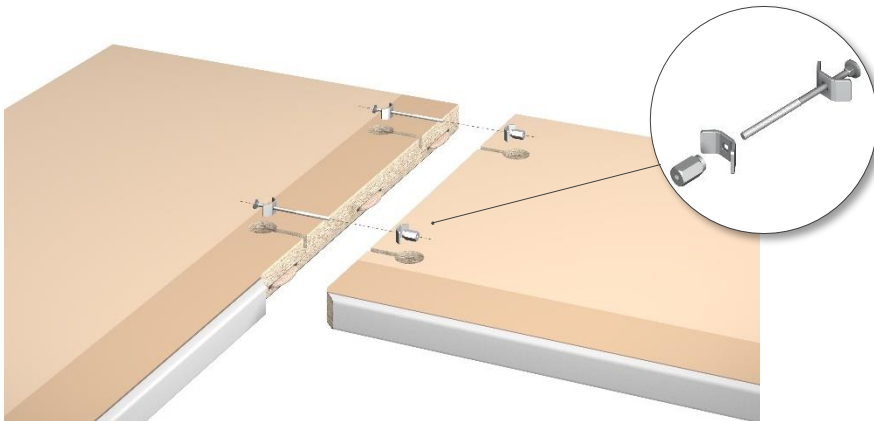

Figure 24

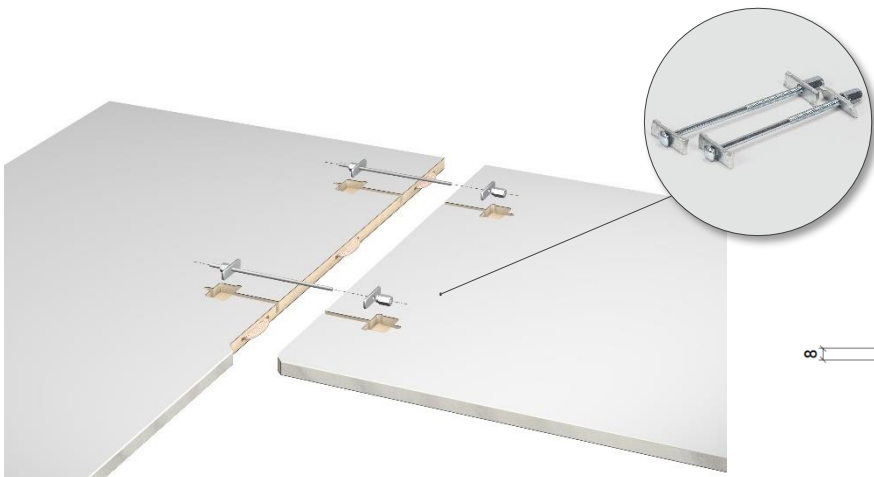

Figure 25

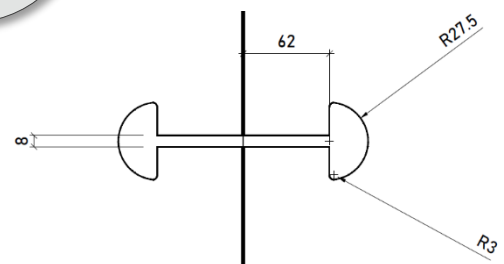

Figure 26

The milling pocket for the 16 mm connector is milled to a depth of 11 mm – see figure 26.

For more detailed information please refer to the technical leaflet "EGGER worktop connectors".

The number of worktop connectors is dependent upon the width of the worktop. In general two connectors are used for widths up to  $\leq 799$  mm and three connectors are used for worktops with a width of  $\geq 800$  mm.

Flush fitting worktop surfaces are achieved by always measuring the locations of the crescent shaped biscuit (Lamello) slots from the top of the worktop surfaces and by ensuring a tight fit of the biscuits themselves.

**The following production steps should be observed:**

1. Remove any raised wood chips near the cut or milled edges with sand paper (grit 120).
2. Bevel the laminate slightly along the joint with a sanding sponge or sandpaper (grit 360).
3. Lay the worktops on the aligned cupboard framework and check the joints and fitting holes for correct fit.
4. Apply glue, D3 quality, to the central and lower area of the joint.
5. Apply sealant (e.g. EGGER sealing) evenly and continuously to the top routed or cut edge as well as to the profile and long back edge. You should do this just before screwing the worktop connectors in place.
6. Join worktops, insert fittings and tighten screws slightly. Align worktops horizontally (wedge or lever) and vertically (rubber mallet or clamps - protect with cushion blocks). Tighten worktop connectors finger tight after aligning. When tightening, you must check that the two worktop surfaces remain aligned and the sealant emerges on all sides. Do not place any stress on the worktops while the sealant is hardening – see figure 23.
7. Remove excess sealant immediately. Clean the worktop surface using a suitable cleaning agent such as citrus cleaner or acetone.  
Caution: Acetone can affect the surface if left for a long period. We therefore recommend masking off the joint area with masking tape.

### 4.3 Fastenings and wall connection

Before sealing the long edge of the worktop against a wall, make sure that it is not just adequately supported, but is also joined to the sub-frame. Stresses can otherwise occur that will interfere with the sealing joint.

The worktop is usually fixed to the base units with screws using the base unit traverses – see figure 27. This conventional fastening is also possible with thin worktops such as the "Thin Square Edged Worktop" and "PerfectSense Topmatt Thin Square Edged Worktop".

However, it must be noted that the contact surface of a thin worktop on the base unit traverses must be adjusted for base units  $> 600$  mm wide to prevent possible bending. For cabinet and worktop stabilisation, EGGER metal traverses have proven themselves, which at the same time allow the worktop to be screwed to the base cabinet – see figures 15 and 16.

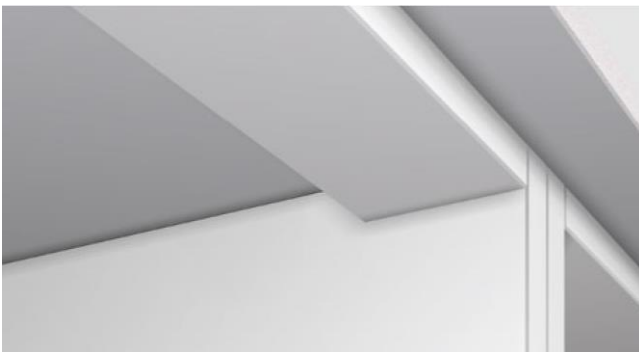

Figure 27

When fitting, make sure that the worktop is not tilted towards the wall. This will result in water collecting at the joint area. Clean and degrease around the sealing area on both the worktop as well as the wall joint and pre-treat with a bonding agent depending on the sealing used.

Even if using worktop wall profiles or EGGER upstands, you need to seal the long back edge and all transverse edges which abut to a wall with sealing – see figure 28. When attaching the fixing rails provided with complete wall seal profile systems, ensure that the laminate is

predrilled in the screw fastening area. The holes must be at least 1 mm larger than the screw diameter to prevent tension building up in the material – see figure 29. We also recommend protecting the inside of the screw hole with sealing before fixing the screw.



Figure 28

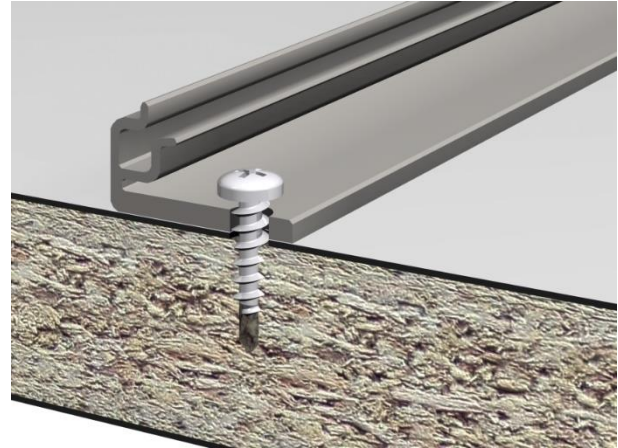

Figure 29

#### 4.4 Structural water-repelling measures

Worktops are particularly subject to steam and heat exposure near dishwashers and ovens. In addition to the lacquer coating and the sealant you should also protect the underside of the worktop by structural means. Self-adhesive aluminium foils generally provide reliable water vapour protection and are easy to handle – see figure 30. Appliance manufacturers supply aluminium repellent strips or protective cover plates, which you must use. This moisture-repellent strip or cover plate deflects and repels steam and heat – see figure 31.

Refer to the manufacturer's instructions carefully before assembling.

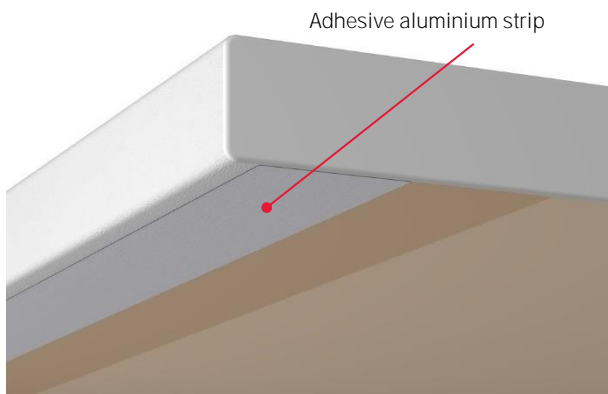

Figure 30

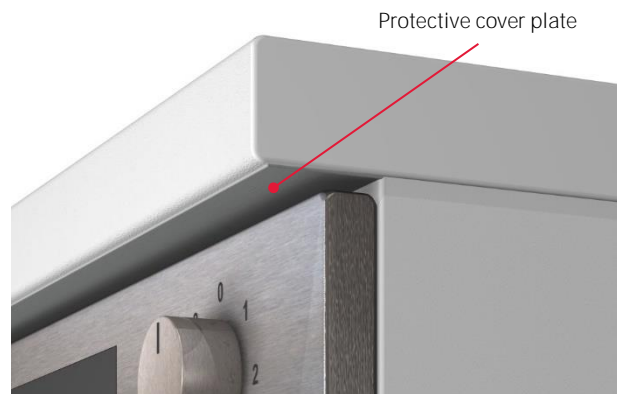

Figure 31

The mounting of the aluminium foil on the underside of the panel differs between models 300 and 100. For the postforming worktop (model 300), the aluminium foil should overlap the laminate infeed by about 2 mm – see figure 32.

For the straight-edge worktop model (model 100), the aluminium foil should be mounted so that it overlaps the ABS edge by about 1 mm – see figure 33.

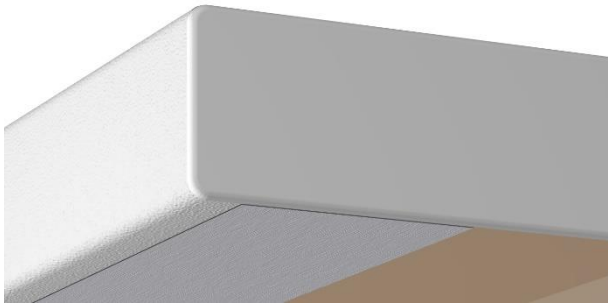

Figure 32

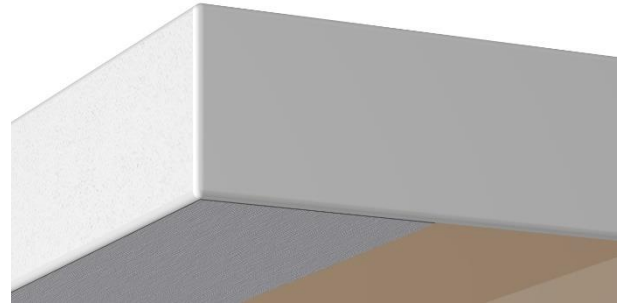

Figure 33

## 5. Maintenance and cleaning recommendations

For detailed information, please refer to the leaflet "EGGER Laminate Cleaning and Maintenance instructions".

## 6. Handling of scraps

Due to their high calorific value, the various worktop designs are very suitable for thermal recycling in appropriate firing systems. If the wood residues are collected by a disposal company for further recycling, they may usually contain a small amount of wood-based materials with ABS edges. How high the proportion of ABS and other so-called impurities may be should be agreed with the disposal company. The country-specific laws and regulations on disposal must always be observed.

## 7. Additional documents / Product information

You will find further information in the following documents:

- Technical datasheet "EGGER Postformed Worktop"
- Technical datasheet "EGGER Feelwood Square Edged Worktop"
- Technical datasheet "EGGER PerfectSense Topmatt Thin Square Edged Worktop"
- Technical datasheet "EGGER Square Edged Worktop"
- Technical datasheet "EGGER Thin Square Edged Worktop"
- Technical leaflet "EGGER Laminate with the surface texture ST9 – Smoothtouch Matt"
- Technical leaflet "EGGER Laminate Cleaning and Maintenance instructions"
- Technical leaflet "Resistance to chemicals – EGGER Laminate"
- Technical leaflet "EGGER fastening set for sinks"
- Technical leaflet "EGGER worktop connector"
- Technical leaflet "EGGER sealing for corner connections"
- Technical leaflet "EGGER metal traverse for base cabinets"

Provisional note:

This processing instruction have been carefully drawn up to the best of our knowledge. The information provided is based on practical experience, in-house testing and reflects our current level of knowledge. It is intended for information only and does not constitute a guarantee in terms of product properties or its suitability for specific applications. We accept no liability for any mistakes, errors in standards, or printing errors. In addition, technical modifications may result from the continuous development of EGGER Worktops, as well as from changes to standards and public law documents. The contents of the processing instruction should therefore not be considered as instructions for use or as legally binding. Our General Terms and Conditions apply.